

F-IDC tracking water injection system

# HFS-3 pwm



User manual -v2

## Getting to know the Aquamist HFS3v2-pwm system

Aquamist has been pioneering the IDC based water injection system since 2003 with great success. The HFS3-pwm system is designed to complete the Aquamist's PWM-valve delivery system line-up, it allows precise metering of water/methanol injection for the modern high performance engine. The dash gauge, flow sensor and "Plug and Play" features are standard to minimise installation time.

The system retrieves the fuel flow (IDC) and manifold pressure signals (MPS) from the engine management system as the prime source to control the flow of water. This enables perfect balance of water to fuel flow under all engine loads. The system can also be controlled by a third-party ECU with its own custom water/methanol flow map.

A "Fast Acting Valve" (FAV) controls the delivery rate based on the PWM signal from the HFS-3 controller. A constant line pressure (160 psi) is provided by the Aquatec pump working in the "by-pass" mode. A PWM valve system guarantees wide dynamic range.

There is a non-gauge/flow sensor option (HFS-2) for non-critical application where a failsafe is not needed. A dash switch is provided instead. The user can disable the system and reduce the manifold pressure to wastegate pressure if needed.

# Contents:

System Check	Page	
	4	Checking the contents of the box
	5	Getting started on the installation
<u>Installation</u>		
	6	Installation for long-term reliability
	7	Generic wiring diagram for HFS-3
	8-9	Choosing jet sizes
<u>System testing</u>		
	10	HFS-3 function directory
	11-12	Quick Start & manual testing
<u>Gauge</u>		
	13	Flow management and other trimmers
	14	Preparation for test run of the system
<u>Dash gauge</u>		
	15-16	Dash Gauge functions
<u>Fail-safe</u>		
	17-19	Setting up the fail-safe
<u>Advanced</u>		
	20-21	Supplementary information on HFS-2
<u>Appendix</u>		
	22-23	Dimensions, Guarantee and Warranty

## Checking the contents of the box carefully

**This is a “must do” immediately after unpacking ....**

### Water pump

Unpack the corrugated sheet carefully. The pump should be labelled with the original custom Aquatec/Aquamist logo. Model number: 58832P0D-B664AM

### The white box

- ◆ 6M of 6mm OD nylon hose (806-261)
- ◆ 2M of 4mm OD nylon hose (806-266)
- ◆ HFS-3 Flow Control Module
- ◆ 0.8 mm water jet (806-323) in plastic bag
- ◆ 0.9 mm water jet (806-324) in plastic bag
- ◆ 1.0 mm water jet (806-325) in plastic bag
- ◆ 1x 4mm Y-piece (806-361) in plastic bag
- ◆ 2x M8 x 1/8 NPT jet adapter with plug (806-357N)
- ◆ A set of three restrictors with insertion tool
- ◆ 1x water tank adapter 1/8 BSP (806-270), 6mm compression fitting and in-tank filter (806-258)
- ◆ 4x M5x40mm bolt, washers and fasteners for pump
- ◆ 1x M6 grounding stud with washer and nuts and 6mm eyelet for pump ground.
- ◆ 2x 6mm to 1/8 BSP compression fitting for pump..
- ◆ 2x 3/8BSP-M to 1/8BSP-F reducer for pump.
- ◆ 1x 4mm to 1/8 BSP compression fitting for FAV.
- ◆ 1x 6mm to 1/8 BSP compression fitting for FAV.
- ◆ Water pump harness. 6M of #12 AWG cable and 6M of multi-core cable with blue harness.
- ◆ 1x Fast acting valve with red harness
- ◆ 1x turbine flow sensor with yellow harness
- ◆ 1x water level switch with connector (806-281c)
- ◆ 1x DDS3v10 Gauge with 2M x 8-way grey cable (HFS-3 only)
- ◆ 1x Dash button with 6-way cable (HFS-2 only)
- ◆ 1.5 M of multi-core with grey capped RJ48 for ECU interface, fail-safe and map switching.
- ◆ Molex type 4-way power in harness
- ◆ User manual

*Note: Please contact your supplier immediately should you discover any missing parts.*

### Before installation guidelines

- ◆ The pump and water tank are designed to be fitted in the trunk. Install the water pump below the water tank if possible.
- ◆ Ensure all fittings are tightened and leak proof before filling up with methanol, **test it with water first**. If a high concentration of methanol mix is used, please vent the tank's breather hole externally. Methanol is poisonous when inhaled.

### Assembling the pump in steps

- ◆ Gently assemble the two 3/8 BSP adapters into the pump without crossing the threads. Ensure the o-ring is properly seated between the fitting and the I/O port. Do not over-tighten.

### Water tank components

- ◆ Ensure the outlet is facing the rear or the side of the tank. Drill/bore a burr-free 23mm hole. Clear up all the burred edges and wash the tank thoroughly. No debris or plastic shavings should remain in the delivery system. 1-2 inches from the bottom of the tank is ideal.
- ◆ Screw fit the in-tank filter on the inlet side of the tank adaptor, insert the assembly into the tank

and tighten the M16 plastic nut. Stop the assembly from rotating with a 6mm allen key into the centre of the assembly. Do not over tighten to avoid splitting the rubber gasket seal.

- ◆ Drill the same hole size for the water level sensor. IF using a washer tank for supply, do not locate the Aquamist float sensor near the stock washer pump. The float arm should swing upwards.
- ◆ A tall and slim water tank is ideal for this type of application. This minimises delivery surge problems at low water level.

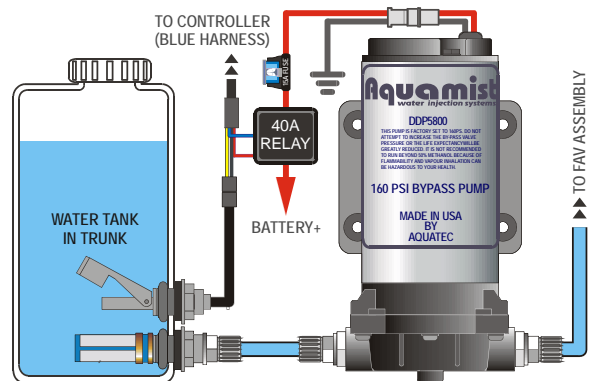

## Installation for long-term reliability

This is the most important section of the HFS-2/3 chapter. Please do not skip reading this part.

### 52mm Dash Gauge (HFS-3 only):

Location is not too critical as long as it is in view of the driver. There aren't too many pitfalls on this.

### Dash switch (HFS-2 only):

A 16mm or 5/8" hole on a flat panel is required for the installation of this switch.

### HFS-2/3 controller box:

Please locate the box in a dry location in the passenger compartment. The glove box is a good place. Please allow plenty of slack to ease accessibility during tuning and diagnostic work.

### Fast acting valve and flow sensor assembly (FAV):

The location of this module is most critical to overall system reliability. It is designed to be installed in the engine compartment.

This module must be installed in a cool, dry and well ventilated area away from any heat source. The bulkhead/fire wall is not always a good location as most heat is flowing towards it during driving. Avoid locations near any electromagnetic components such as the ignition coil, solenoid valves and electronic motors. It is very important that the hose is cut cleanly with a razor blade to retain the "roundness". The use of side cutters produces a semi-round hose end, resulting in a major leak sooner or

later. It is also vital that the hose must be cut perpendicular/square relative to its length. This is because the compression fitting has a short hosetail. An accurate cut will allow maximum grip on the walls of the hose.

Ensure the thin rubber gasket is placed between the FAV coil and electrical plug (red harness) before tightening. Press the clip of the yellow harness into the centre section of the flow sensor body, Orientation is not important. Ensure the electrical plug's cable outlet is facing downwards. All cables leading away from the assembly must be looped downwards to avoid condensed water trickling into the clip and plug.

### The tank level sensor:

Drill/bore the same hole size for the water level sensor. A 23mm burr-free hole must be used to ensure a good seal. The float arm should swing upwards. Check that there is ample room for the sensor arm to swing before drilling. A tall and slim water tank is ideal for this type of application. This minimises delivery surge problems at low water levels.

If the stock washer tank is going to be used, do not mount the float near the stock washer pump. The motor magnet will affect the sensor reading properly. The sensor can be installed 3/4 way down the tank, preferably at the rear facing wall of the tank. Never over tighten or the seal will split; just tighten enough

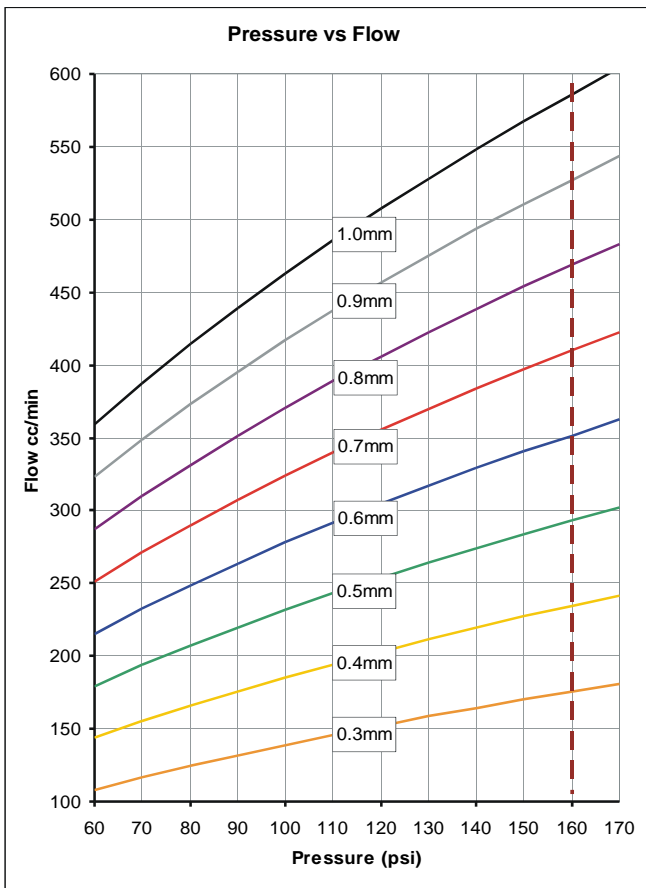
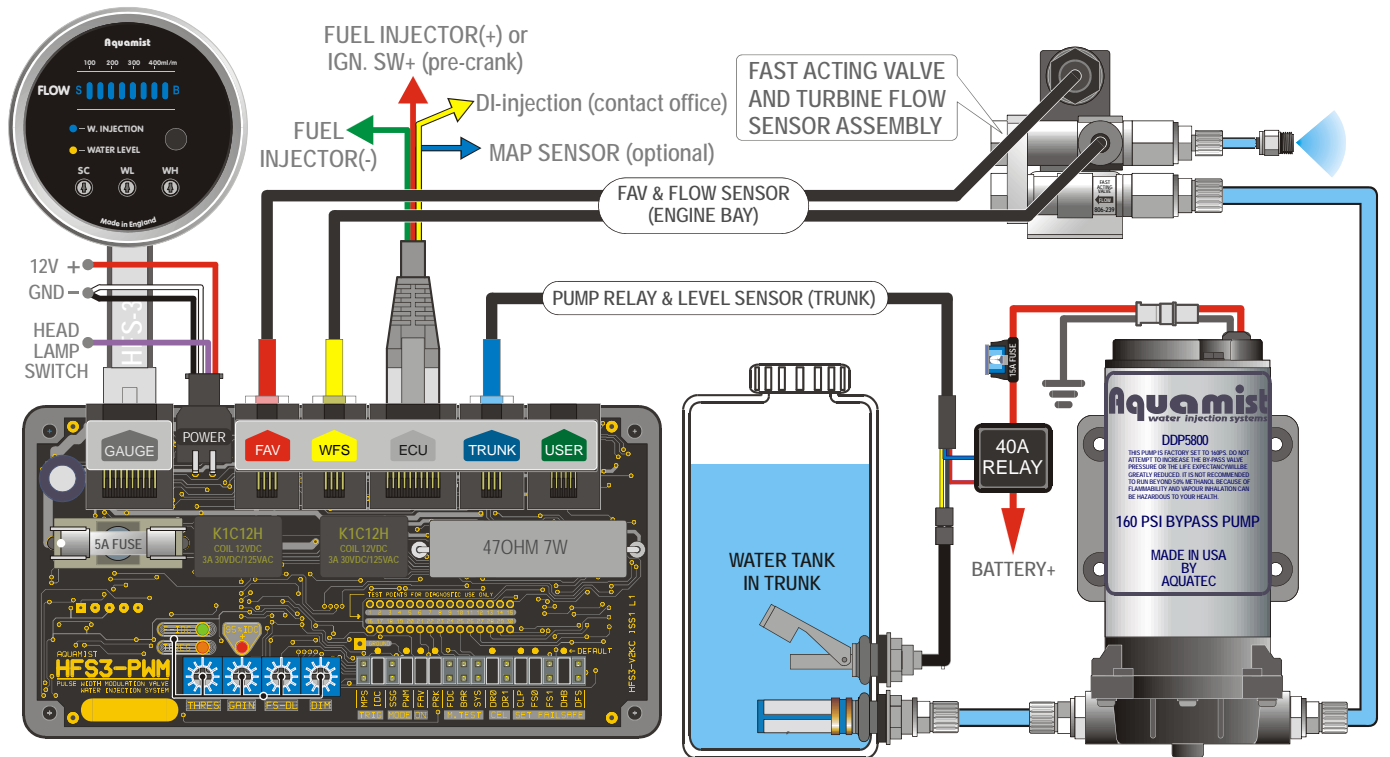

**This is a general guide only:**

- 100% water: run 10-15% water/fuel ratio.
- 50:50 methanol/water, run 15-20% to fuel.
- 100% methanol, run 20-25% to fuel

**Choosing the jet by calculation:**

First work out the total fuel flow by adding up the capacity of the fuel injectors. Multiply the result by the preferred % recommended above.

Pick the nearest jet/jets size to match the flow. Don't forget to subtract the boost pressure from the line pressure of 160psi. For example, if you are boosting 25psi, you should select the jet flow at 135 psi.

Once the jet/jets and flow are determined, insert the nearest larger restrictor to regulate the fluid flow so the delivery will be linear to the duty cycle.

JET	60	70	80	90	100	110	120	130	140	150	160	170	PSI
0.3	108	116	124	132	139	146	152	158	164	170	176	181	FLOW RATE: CC/MIN
0.4	144	155	166	176	185	194	203	211	219	227	234	242	
0.5	194	207	220	232	243	254	264	274	284	293	302	309	
0.6	215	233	249	264	278	292	305	317	329	340	352	362	
0.7	251	271	290	308	324	340	355	370	384	397	410	423	
0.8	287	310	332	352	371	389	406	423	439	454	469	483	
0.9	323	349	373	396	417	437	457	475	493	511	527	544	
1.0	359	388	414	440	463	486	508	528	548	567	586	604	

The HFS-2/3 is supplied with a set of high-flow water jets, sized at 0.8, 0.9 and 1.0mm (see chart for flow rate). A Y or T is supplied with the kit for twin jet applications. There are two nickel plated brass jet adapters (1/8 NPT). The tapping hole should be 11/32" or 8.8mm. Do not over tap. Clean the mating part with alcohol first, trial fit before loctiting into position.

Three restrictors are supplied for duty cycle/ flow matching should good linearity be required.

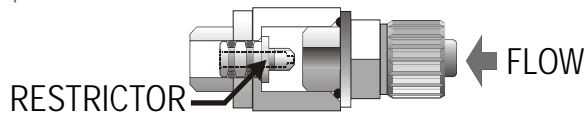

For flow grater than 1100cc/min you can omit it. I should be fitted in the hose side of 6mm fitting of the FAV assembly.

Undo the in compression fitting from the FAV inlet port. Use the threaded insertion tool to push the restrictor in position, Apply a smear of grease to avoid damaging the o-ring.

- 0.5mm restrictor ..... 0 - 380cc/min
- 0.7mm restrictor ..... 0 - 680cc/min
- 0.9mm restrictor ..... 0 - 1080cc/min

**Applications involving methanol mix beyond 50%:**

Great care and attention must be taken to ensure the fluid tank is capable of handling methanol and is designed for this type of application. These tanks are normally termed as a Fuel Cell and are available from most reputable racing parts suppliers. Anti-surge foam should be used for circuit racing. Follow the maker's guidelines carefully.

The breather hole must be vented externally with a suitable hose. All fluid delivery hoses and fittings must be free of all leaks. Ensure the area is well ventilated and isolated from the driver's compartment. Take whatever measures to avoid any methanol fumes building up in trunk area.

**Methanol is highly flammable.** The main delivery hose to the engine bay should be routed underneath the car. Ensure it is securely clipped and fastened. Avoid kinks and close proximity of moving parts and heat producing components. Please treat this recommendation seriously. If in doubt, ask advice from a professional person familiar with this kind of application. DO NOT take any undue risks. It is recommended that a suitable fire extinguisher is placed within easy reach of the driver. All electrical connections must be properly tightened to avoid spark production.

**Warning: Prolonged use of 100% methanol may cause premature pump failure and may not be covered under warranty.**

HFS-3 function directory

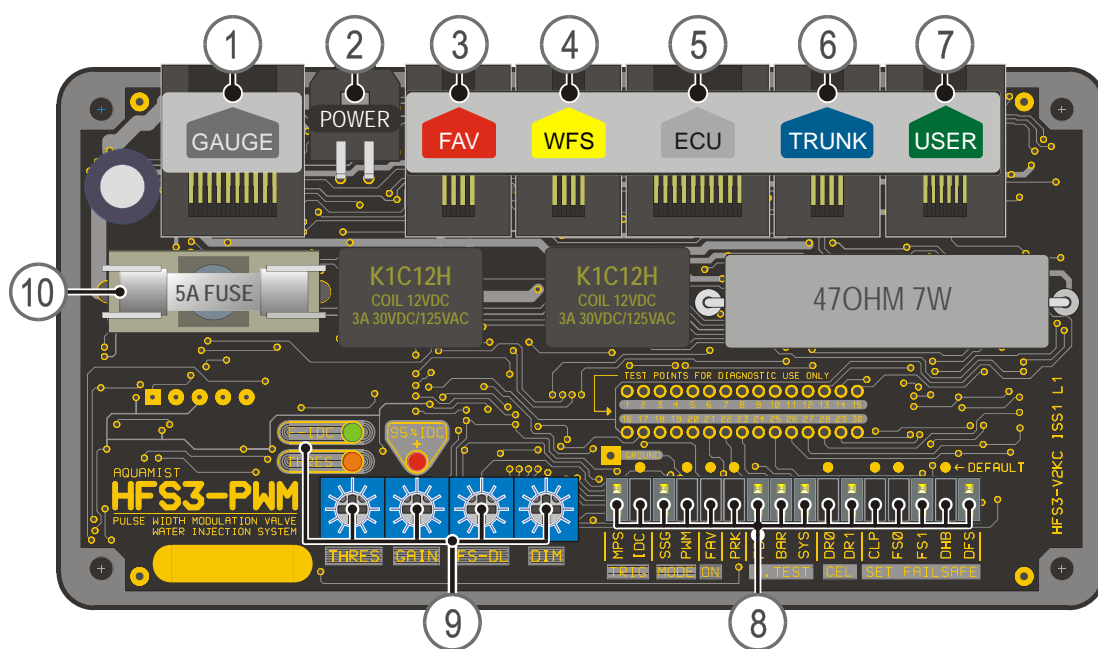

- 1. DASH GAUGE (P.15)
- 2. 12V, HEAD LIGHT SWITCH and GROUND (P.11)
- 3. FAST ACTING VALVE in ENGINE BAY (P.6)
- 4. WATER FLOW SENSOR (FAV CLUSTER) (P.6)
- 5. ECU INTERFACE AND FAILSAFE (P.11/18)
- 6. WATER TANK and PUMP in TRUNK AREA (P.5)
- 7. FUTURE SYSTEM EXPANSION PORT
- 8. SYSTEM CONFIGURATION BY USER (P.12)
- 9. FLOW & SYSTEM MANAGEMENT TRIMMERS (P.13)
- 10. 5A 20mm x 5mm FUSE LINK

**Mechanical work (checklist):**

Only after testing with distilled water should methanol be used. BEFORE hooking up line to the jet the system should be manually activated to flush any possibly dirt/debris from the lines.

**Wiring work (checklist):**

The HFS-3 is pre-configured from the factory. Plug in the following harness for testing the power supply into the controller.

**1. 4-way Power-in connector:**

- Red ..... Switched 12V (IGN SW#2)
- Black ..... Chassis ground
- White ..... Chassis ground
- Purple ..... Head lamp switch (optional)

**2. Signal to the grey RJ48 connector:**

- Red ..... Ignition switched 12V
- Green ..... Fuel injector (-) pin
- Blue .....MAP sensor (optional)

**3. grey flat cable to the Dash Gauge**

**Power-up procedure:**

Please follow this procedure "strictly" or permanent damage to the system may result. Do not **SKIP** any steps please....

**1. Ignition key on the "OFF" or "0" position:**

- Dash Gauge button is depressed (system on)
- No leds should be lit anywhere.

**2. Ignition key on the "ACC" or "#1" position:**

Absolutely no change, same as the above conditions.

**3. Ignition key on the "pre-cranking" or "#2" position:**

- Do not crank. Observe the gauge and controller leds
- Yellow led on the gauge will stay lit for 5-10s before the rest of the gauge lights up.

**4. Start the engine and let it idle for a minute or so:**

- The green led on the controller should flicker
- The flicker should speed up with engine speed.
- If the system behaves as stated above, you have successfully wired up the HFS-3!

**Now plug in the rest of the harnesses:**

- The "S" led should confirm the presence of the flow sensor.
- The yellow led will activate if the tank level is low.

This completes the basic system test. The next stage will be testing the system manually by using the jumper links on the controller board. You will need a small 3/32" slotted screw driver. .

**Knowing the default controller functions:**

(function explained from left to right)

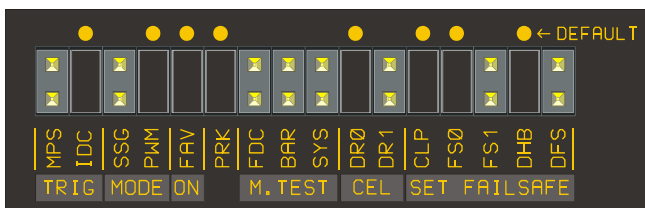

**1. TRIG:**

The system is set to triggered by IDC (fuel injector duty cycle) % from factory. The alternative mode is MPS (Manifold Pressure Sensor). Flow will remain progressive with fuel injector duty cycle.

**2. MODE:**

PWM mode (factory default). Flow is progressive with IDC. The user can set the system to inject as SSG (single stage) mode, ie "all on" or "all off".

**3. FAV:** Enable (default) or disable inline valve.

**4. PRK:** Parking for unused jumper link.

**5. TEST:**

- **FDC:** Link to display FIDC on gauge (testing only)
- **BAR:** Link to test bargraph with the "SC" trimmer.
- **SYS:** This link can be used to activate the pump only for the purpose of priming the system.

Unlink the #3 (FAV) to disable FAV to avoid hydro-lock.

**6. CEL:**

Boost cut without CEL (check engine light) activation. This is only used in conjunction with internal relay fail-safe output. DR1 = No CEL.

**7. F. SAFE OPTIONS:**

CLP, FS0, FS1 configure the "map-switch" output,

- **CLP (factory default):** Output voltage is clipped from 8V to 5V.
- **FS0 (factory default):** Fail-safe output to ground upon activation
- **FS1:** Fail-safe output switches from 0 to 5V or 8V upon activation. (this fail-safe output option is on the pink wire of the grey harness.
- **DHB (default=linked):** "Disable High Boost". When the gauge is switched off, all fail-safe outputs become activated. This safe guards any engine damage. If the DHB is "unlinked", the yellow led (water level) will be lit when the gauge is switched off, giving user a reminder that the system is not protected.
- **DFS (default=unlinked):** "Disable Fail Safe". Link to stop the fail-safe activation during test or preliminary test run prior to finalising fail-safe window. .

### Setting the onboard trimmers: (default=12 o'clock)

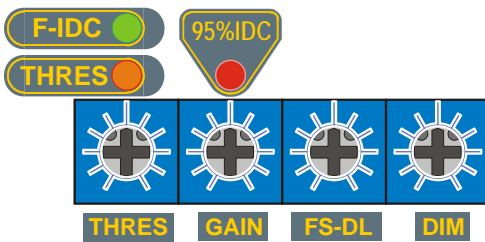

The system requires no trimming from the factory. If the user wants to alter the flow and other parameters, just use a small screw driver to complete the task. Below are the working details of each trimmer. (left to right).

#### 1. LED panel:

Three leds monitor the real time operation of the system,

- **Green (F-IDC):** Blinks upon successful detection of fuel injector duty cycle signal. The blink rate and brightness increase with engine speed and duty cycle respectively.

- **Amber (THRES):** At 44% F-IDC (default), this led will activate, confirming the system is triggered and delivery commences.

- **Red (95% DC):** When the water/methanol duty cycle is approaching 95%, The red led begins to turn on, indicating that you have almost reached the maximum flow of your system. More flow requires additional jets.

#### 2. Trimmers for fine tuning:

- **THRES:** Factory set to 44%, User adjustment range is between 12-72%.

- **GAIN:** User can define the slope of water/methanol relative to F-IDC by +/- 50%. The factory slope is set to 1:1 ratio of fuel duty cycle. Useful tool to compensate low F-IDC when large fuel injector is used. It can also be used to trim flow at high F-IDC.

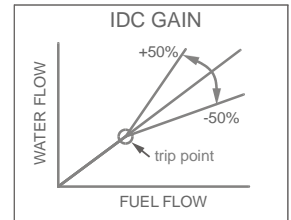

- **FS-DL:** Fail-safe delay to undue fail-safe activation due to spike and noise signal from the flow sensor. The factory default setting (12-o'clock) is 400mS (milli-second). User adjustable between 200mS to 600mS.

- **DIM:** This trimmer works in conjunction with the head lamp switch. When it sees a 12V signal, the trimmer becomes active. This coincides with night drive conditions. The high-intensity led used on the dash gauge is too bright for night motoring, so wiring in the "purple wire" from the 4-way power plug to the head lamp switch is essential. Do not wire it to the car's interior dimming circuit or unexpected results may occur.

## Preparation for a test run of the system

### 1. First step - system check list:

- Tank and pump is fully secured and leak free.
- The FAV assembly is securely located in a cool and dry spot of the engine bay.
- The controller is accessible and can be secured down with minimum movement during motoring,
- The jets are securely installed in the inlet tract.
- Dash gauge installed.

### 2. Priming and purging of the system:

- Fill up the tank with water half way.
- Disconnect the 6mm hose from the FAV assembly and put the hose into a container securely.
- Ignition switch in pre-crank position and gauge is switched on. Uncover the controller and pull out the "Inj" jumper (disabling the FAV) and put it to the link marked "SYS". The pump should power up and water should come out of the 6mm hose within a few seconds, Let it run for a 10-20 seconds so that trapped air and debris are purged.
- Listen to the pump during the priming period; it should go very quiet after completion of purging procedure. If not, repeat step "c".
- Upon successful completion of the above, reinsert the 6mm hose into FAV assembly.

### 3. Testing the spray pattern of the jets:

- Secure an unused jet onto the windscreen and connect it to the outlet port of the FAV assembly.
- Activate the system by linking up " INJ" and "SYS" on the controller. You should see an instant full-cone spray at the jet. Do it for a few seconds only. You can repeat the test with the remaining jets. At the same time the gauge should register a few bars. Remove the "SYS" test link.

### 4. Activate the system by F-IDC:

- Set the far left trimmer to fully counter-clockwise. Crank the engine and leave it to idle, you should see the blinking green led on the controller board.
- Blip the accelerator paddle sharply to induce an artificial load. The amber led should respond. A faint but noticeable spray should develop at the jet.

### 5. Road test the system:

Still with jet on windscreen, make a short drive and confirm the spray is progressive with load. After a successful road test, reconnect the hose to the internal spray jets. This concludes the system test,

The system is ready for the next stage - fail-safe setting. At anytime if there is a problem, please contact us.

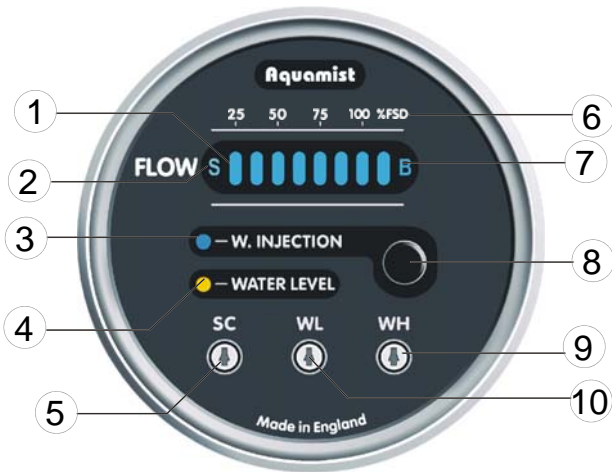

**1. 8-element Bargraph Display (80-1800ml/min)**  
Each segment is equivalent to a percentage of the total flow of the sensor scaled by the SC potentiometer.

**2. "S" indicates the presence of a flow sensor.**  
The letter "S" (sensor) must be lit after power up and stay on to show the flow sensor is functioning correctly.

**3. Water injection system ON led**  
This led comes on when the system is switched on and is ready to inject.

**4. Water Level led (yellow)**  
(This LED has three functions)

**a. During "power on delay" period:**  
This LED will activate for approximately for 10 seconds during the system-on delay before the main system turns on.

**b. During normal operation period:**  
- This LED is on during the fail-safe activation  
- Water level low (intermittent flashes)

**c. Led lit after the gauge is switched off:**  
- If the water level sensor is activated for over 20 seconds.  
- fail-safe disabled by DHB (p21.6).

**5. SC (Sensor Calibration)**  
20-stepped potentiometer allow user to scale the flow sensor to give an ideal visual indication of a given flow rate. Ideally set the led to display 5-6 bars at full flow.

**6. Backlit flow legend**  
Legend displays % of full scale of 8-bars

**7. "B" High Boost Enabled led**  
When the flow falls inside the fail-safe window after system trigger, this "B" led will activate. Useful indicator of the WL and WH setting.

**8. Water injection enable button**  
Due to extra power level achieved under WI, user may want to reduce the power to the wheels in less than ideal driving conditions. Disabling the WI will reduce boost to wastegate bleed valve setting (if fitted) as well as switching to a less aggressive MAP on custom engine management.

**9. Over-range setting potentiometer (WH)**  
It is just as important to monitor over-range conditions as well as under-range flow conditions. If a leak develops close to the water jet and starves the engine of the water, the user must know this condition. A 20-stepped potentiometer allows accurate and repeatable adjustment range.

**10. Under-range setting potentiometer (WL)**  
This setting can indicate partial blockage and trapped air inside a delivery hose. Again a 20-stepped potentiometer is employed. Each click represents a fixed portion of the window width of 8-bars.

WL covers the lower 4 bars of the display and the WH covers the upper 4 bars. Figure on the right illustrates the span of the coverage. Setting is very simple once SC is calibrated.

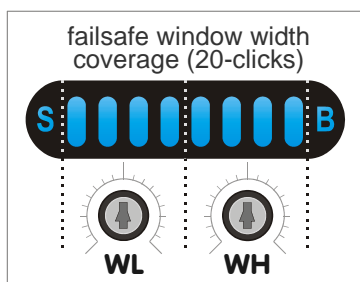

**NOTE:**  
In order to make the fail-safe adjustment easier, it is recommended to set the bargraph to display 5-6 bars at maximum flow. This way, the fail-safe window can span from the centre outwards.

If the WL and WH is set at 12 O'clock, the fail-safe window is approximately spanned between 2-7 bars. This is a good starting point.

Minor trimming for the WL is necessary if the water injection trigger point is set to commence earlier.

**The gauge will display the activation of the "fail-safe" with two leds:**

**1. "B" led** (right of the bargraph) will only stay activated if the flow is inside the fail-safe window during injection period.

**2. The "yellow" led** (water level) will activate if the flow is outside the fail-safe window during injection.

As soon as the "fail-safe" is tripped, there will be a 3 second reset period before it reset while the fail-safe drops boost.

When gauge is switched off, expect low boost and safe map unless the board is re-configured. (page 12.7)



**This final stage should be quick, simple and effective; please read it before proceeding. It will save you time in the long run.**

If fluid flow falls inside the fail-safe detection window after triggering, no action will be taken. So setting up the width of the window to accommodate the full fluid flow is vital.

Setting up the fail-safe should only be done after the car has been tuned or the jet/jets sizes are finalised.

**Recommended steps to set up the fail-safe**

1. Adjust the "SC" to display 5-6 bars at full power.
2. Make a mental note of the number of displayed bars during spool up. This is made easier at higher gears.
3. Set the WL to match the number of spool-up bars. It is recommended to allow 2-3 clicks below that point to avoid false triggering. Full span of WL is 20 clicks, covering from 0 bar to 4 bars.
4. Same procedure is used to set up the WH, allowing 2-3 clicks above 6 bars. Full span of WH is 20 clicks covering 4-8 bars.

This completes the fail-safe set-up ...

**What steps to take after the fail-safe triggers**

The most common way to minimise engine damage in the absence of injection is to reduce the boost pressure.

1. **For engines with electronic boost control valve:**  
The grey harness contains a set of relay contacts that goes open circuit when the fail-safe is triggered. See page 18.2 and 19 for more details.
2. **For engines with MBC (manual boost controller):**  
The onboard failsafe relay can be used to control a 3-port solenoid valve to by-pass the MBC. Essentially reducing full turbo boost to the wastegate. See page 19 for more details.
3. **For an engine with map switching capabilities:**  
The pink wire on the grey connector has a dedicated output to perform such a task. This pin can be user configured to match the signal requirement of the "third party" ECU to switch map. See page 18-1 for more details. This pin is factory configured to give a 5V for "OK" and "0v" is "flow fault" Maximum current of this output is 5mA.

**Note:** For Mitsubishi Evo, this output can perform automatic "map switching" by utilising tephra patch More details is available at the EVOM forum.

**1. The Map Switching Channel (HFS-3 only):**

The orange wire from the grey RJ48 connector is dedicated for the use of MAP Switching when an ECU is equipped with this input. This wire is factory configured to send out a voltage of 4.7V DC under a "no fault " condition, from idle to full boost. This voltage will switch to 0v upon a fail-safe activation or the gauge is switched off.

Other voltages such as 0, 5V or 8V can be user configured (page 12.7) This is by far the most effective method to save your engine from lack of water injection. A jumper link can invert the map switch output if necessary.



**2. Change-over relay: (HFS-2/3)**

The HFS-2/3 has an onboard relay to supply a set of voltage-free, change-over contacts for the sole use of fail-safe activation. It can be used to perform various tasks to save your engine. Contact rated up to 1 amp.

**Gauge Off:**

- White/Black ..... close circuit
- White/brown ..... open circuit

**Gauge On (non-injection period):**

- White/Black ..... open circuit
- White/brown ..... circuit circuit

**Gauge On (fail-safe activation):**

- White/Black ..... close circuit
- White/brown ..... open circuit

**Example 1 (most common):**

Disabling the OE boost control valve. "Cut and splice" the boost control circuit. "ECU side" to White. "BCV side" to Brown. Need to link the "Anti-CEL" option on page 12.5. to avoid the onset of CEL during fail-safe activation.

**Example 2:**

Disabling the third party electronic boost control system. "Cut and splice" the pulsed wire to the BCV, "Controller" side to White and "BCV" side to Brown.

This option will not work with EBC (Electronic Boost controller) utilising a stepper motor to control boost. HKS-EVC is such an example. Use the MAC valve option on page 17.

**Note:** Although the dash button of the HFS-2 can energise the relay it has no provision to de-energise the relay if the water jet is clogged. It will however de-energise the relay if the water level is "low" and "power" to the system fails. There is a direct upgrade path to HFS-3 from Aquamist. Please submit your request directly.

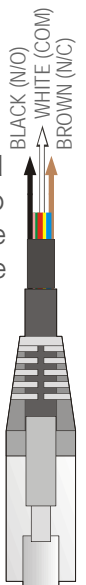

**Upon detection** of water flow fault, the HFS-3 can reduce the boost pressure of a third party EBC or MBC to wastegate setting. This can be accomplished by using the internal fail-safe relay and a MAC valve.

The HFS-3 does not include this valve, You need to order one from [www.howertonengineering.com](http://www.howertonengineering.com)

Figure below shows two common types of MBC (manual boost controller) used on most turbo cars.

**Type 1:** pressure from the turbo to the wastegate is vented to the atmosphere via a restrictor and a vent. Boost increase is proportional to the amount vented.

**Type 2:** Boost increase is proportional to the spring pressure of the MBC.

When the solenoid valve is energised, pressure from the turbo is diverted to the wastegate directly. When MBC is by-passed, the boost pressure will drop down to wastegate setting.

**NOTE:** The same MAC valve can be used to reduce boost on any Electronic Boost control valve system. Use the same hose configuration as the "TYPE 1", with Port 2 blocked-off. CEL=OFF (page12.6)

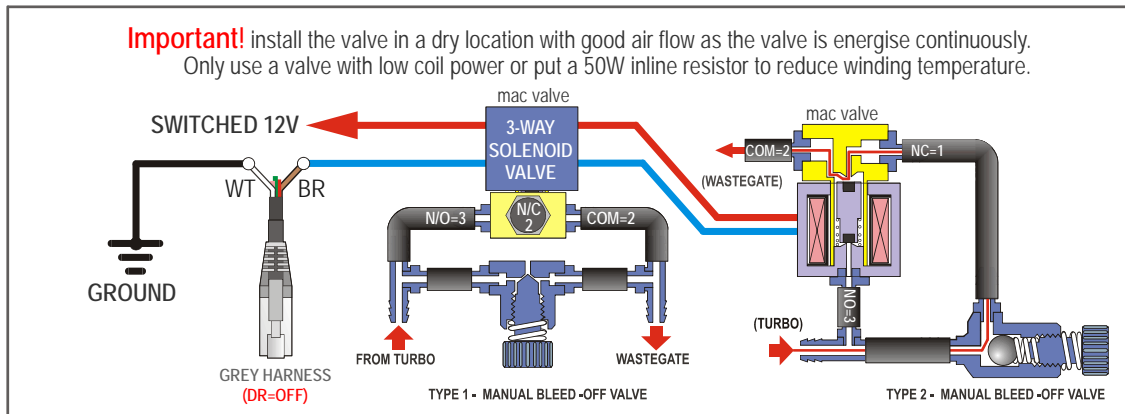

Supplementary information on HFS-2

**The HFS-2** shares the same electronic controller as in the HFS-3. The only difference is the dash gauge and flow sensor is not supplied. However, a dash switch is supplied instead. There is a simple upgrade kit to HFS-3 available direct from factory.

**The design concept behind the HFS-2 system:**

Not every application requires a fail safe to reduce power in the event of a clogged jet or system failure. In those circumstances, water injection is only used as a tool to recover power loss due to low fuel octane and high ambient temperatures. When water is injected, it will suppress the onset of knock and lower the intake charge air temperature. The ECU will not need to retard timing or add fuel to combat those situations.

The HFS-2 is particularly suitable for countries with high ambient temperatures. Due to its unique abilities to mirror the fuel duty cycle from as low as 12% to 100%, this ultra wide dynamic range is perfect for day to day motoring and occasional power blast.

Another effect could improve the fuel consumption due to optimum ignition timing is retained as well.

**The HFS-2 Dash switch:**

Other than the on/off usage of disabling the system from injecting, there are three display modes indicating the status of the system. A green led indicates the system is armed and on standby by to inject. When the preset trigger point is reached the green led will blink at a steady rate, informing the user the system is spraying.



When the water tank level drops below the level sensor probe, the green led will change to yellow, Initially it will oscillate between the two colours until the water is well below the sensor probe, it will turn solid yellow. At about 20 seconds later, the system will automatically stop injecting to prevent air entering the system.

One more useful function, the internal fail-safe relay works in unison with the status of the dash switch until the tank is empty or DBH (disabling high boost) mode is turned off (jumper link removed). This function is making use of the relay whereas lying idle.

# Generic wiring diagram of the HFS-2

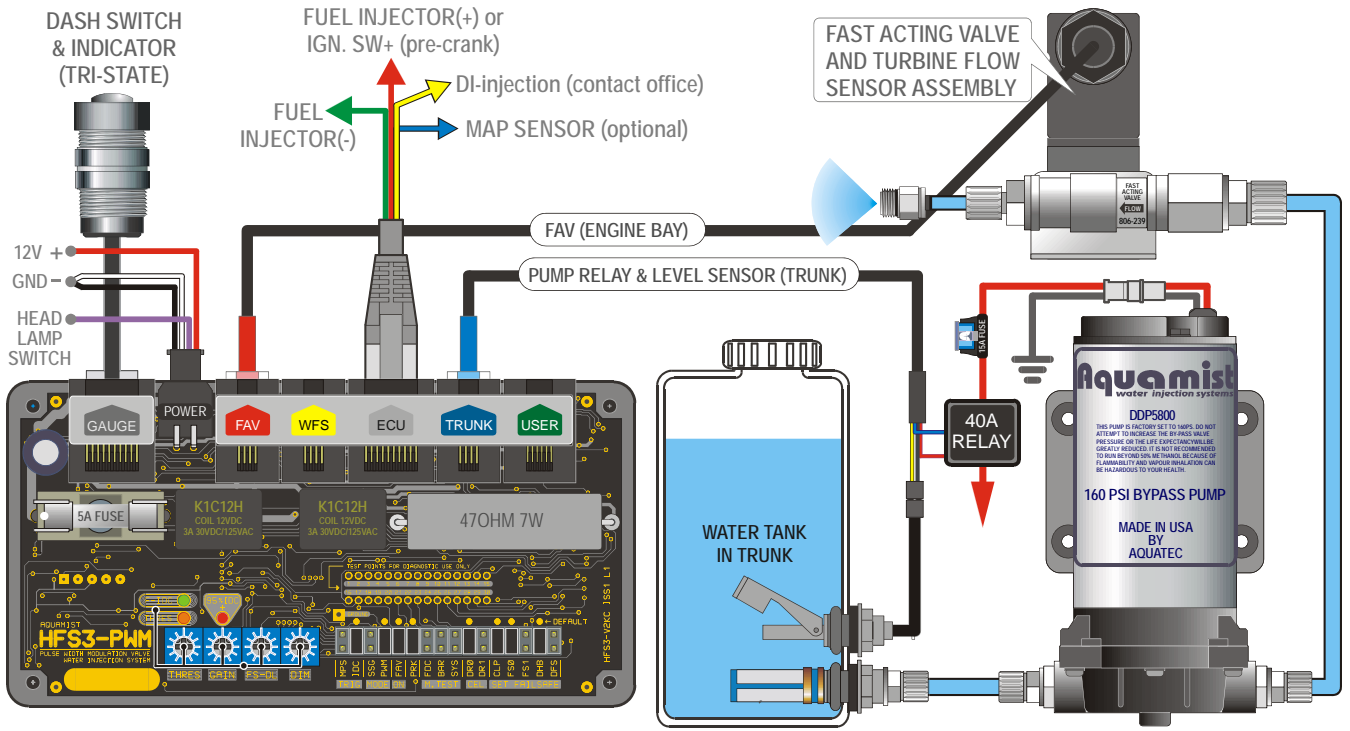

Note: Please ensure the correct harness is plugged into the appropriate socket to avoid causing permanent damage to the Electronic controller. The potentiometers on the controller are preset to mid-position from factory. System triggers at 40% of IDC. Fuel-IDC to Water-IDC ratio is 1. The system will operate correctly without any adjustments.

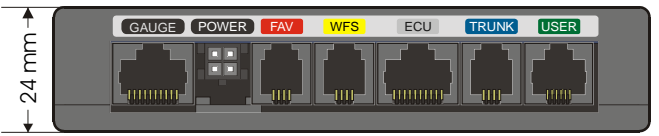
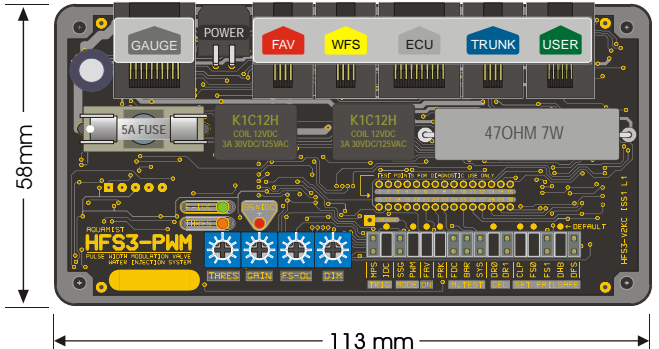
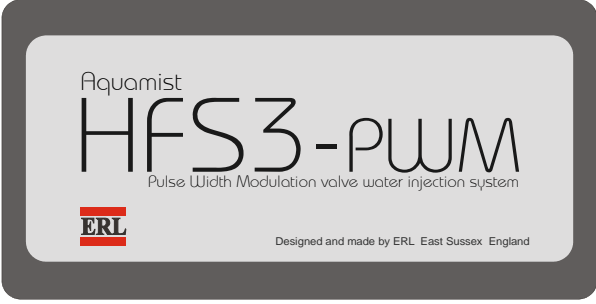

# Appendix

**In Car Dash Gauge (2M)**

Pin	Colour	Size	Description	Electrical parameter
1	(HFS-2)	24awg	Dash indicator red or green led	20mA @5V max.
2	red	24awg	+12V power supply to gauge	250mA max@12v
3	green	24awg	Flow Sensor output voltage	0-5 VDC @10mA
4	pink	24awg	0V power supply to gauge	250mA max@12v
5	white	24awg	Internal communication signal	-
6	yellow	24awg	Float Sensor from water tank	Ground active
7	blue	24awg	Flow Sensor calibration output voltage	5-0 VDC @1mA
8	black	24awg	Night driving dimming connection	+12V active
9	brown	24awg	Wastegate bleed valve option (SW-)	1A @12V max.
10	(HFS-2)	24awg	Dash indicator yellow led	20mA @5V max.

**Molex Microfit power harness (2 M): Main Power supply and Dimmer control**

1	red	20awg	+12V Power supply (switched)	250mA max@12v
2	purple	20awg	Gauge dimming input to head lamp switch+	0-5 VDC @10mA
3	white	20awg	0V Ground (signal ground)	250mA max@12v
4	black	20awg	0V Ground (Power ground)	-1A @12V max.

**Red Harness to Engine bay (2.5M): To Flow Control assembly**

1	red	24awg	+12V PSU to Fast acting valve	1A max @12v
2	yellow	24awg	+12V PSU to Fast acting valve	1A max @12v
3	blue	24awg	PWM ground switch to Fast acting valve	1A max @0v
4	black	24awg	PWM ground switch to Fast acting valve	1A max @0v

**Yellow Harness to Engine bay (2.5M): To Flow Control assembly**

1	red	24awg	+5V Power supply to Turbine flow sensor	5mA max @5v
2	yellow	24awg	Turbine fow sensor signal output	1mA max @5v
3	blue	24awg	Feedback signal (return ground)	1mA max @0v
4	black	24awg	0V/ground power supply	1mA max @0v

**Grey Harness to EMS (2.5M): IDC/Boost detection and Fail-Safe / Map-Switching interface**

1	==	24awg	Future extension I/O channel1	-----
2	red	24awg	Ignition Switching detection	30mA max@12v
3	green	24awg	Fuel injection IDC detection	10mA max@12v
4	pink	24awg	Map switching interfacing	0, 5V, 7.5V @1mA
5	white	24awg	Failsafe Relay contact (COM, Wiper)	1A @24V max.
6	yellow	24awg	Reserved for internal communication	Signal level
7	blue	24awg	Map Sensor Signal input	0-5 VDC @1mA
8	black	24awg	Failsafe Relay contact (N/C contact) or DR	1A @24V max.
9	brown	24awg	Failsafe Relay contact (N/O contact)	1A @24V max.
10	===	24awg	Future extension I/O channel 2	-----

**Blue Harness to Trunk Area (6M):**

1	red	24awg	+12V Power supply to 40A relay	0.5A max @12v
2	yellow	24awg	Water level sensor signal	signal ground 0.5A
3	blue	24awg	Pump relay activation (ground switch)	-----
4	black	24awg	Water level sensor ground	-----
9	Red	12awg	12V Power cable to water pump relay	38A @12V max.
10	Black	12awg	0v ground for water pump	38A @12V max

Green Harness: user port (2M): Reserved for future expansion.

**GUARANTEE**

ERL guarantees, at our option, to replace faulty goods supplied or repair the same, subject to the claim made in writing to us within 12 months after the sale by us, or for such other period as may be indicated by us for specific products in lieu of any warranty or condition implied by law as to the quality or fitness for any particular purpose of the goods.

Any claim against us must be made to us in writing within the period of 12 months after the sale by us, or our agents, or our distributors of goods in question (or such other period as may be indicated by us) and any goods to which the claim relates must be returned to us within that period suitably packaged and cleaned and, with any particular instructions which we may have notified to you at the time of supply. Original invoice, the nature of any claimed defect must accompany the goods in question prior to despatch to us.

If these requirements are not complied with our Guarantee shall not apply and we shall be discharged from all liability arising from the supply of defective goods.

**LIABILITY**

We shall not be under any liability whether in contract, or tort or otherwise and whether or not resulting from our negligence or that of our employees, in respect of defects in goods supplied or for any damage or loss resulting from such defects.

We shall not be under any liability for damage, loss of expense resulting from failures to give advice or information or giving the incorrect advice or information whether or not due to our negligence or that of our employees.

In no event shall any breach of contract on our part or tort (including negligence) or failure of any time on our part that of our employee give rise to liability for loss of revenue or consequential loss or damages arising from any cause whatsoever.

Note: ERL reserves the right to make changes to our products without notice in order to improve design performance and reliability.

## Useful Aquamist technical links

Aquamist owners have been pretty good in supporting each other. Most experienced users will help new users with questions, not necessary to email or make long distance phone calls and wait on hold to get help. Here are a list of forum links where users can seek help and advice from others:

- <http://www.waterinjection.info> (general)
- <http://forums.nasioc.com/forums/forumdisplay.php?f=145> (Subaru)
- <http://www.iwsti.com/forums/water-meth-injection-nitrous-intercooler-cooling/> (Subaru:sti)
- <http://forums.evolutionm.net/water-alcohol-injection-nos-173/> (Mitsubishi evos)
- <http://www.rx7club.com/forumdisplay.php?f=173> (RX7)

# END